

Installation and User's Manual ver 1.0

SC3100

SC3100 PTZ CONTROLLER

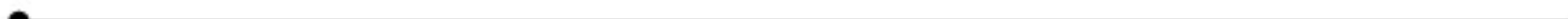

SC3100

PTZ CONTROLLER

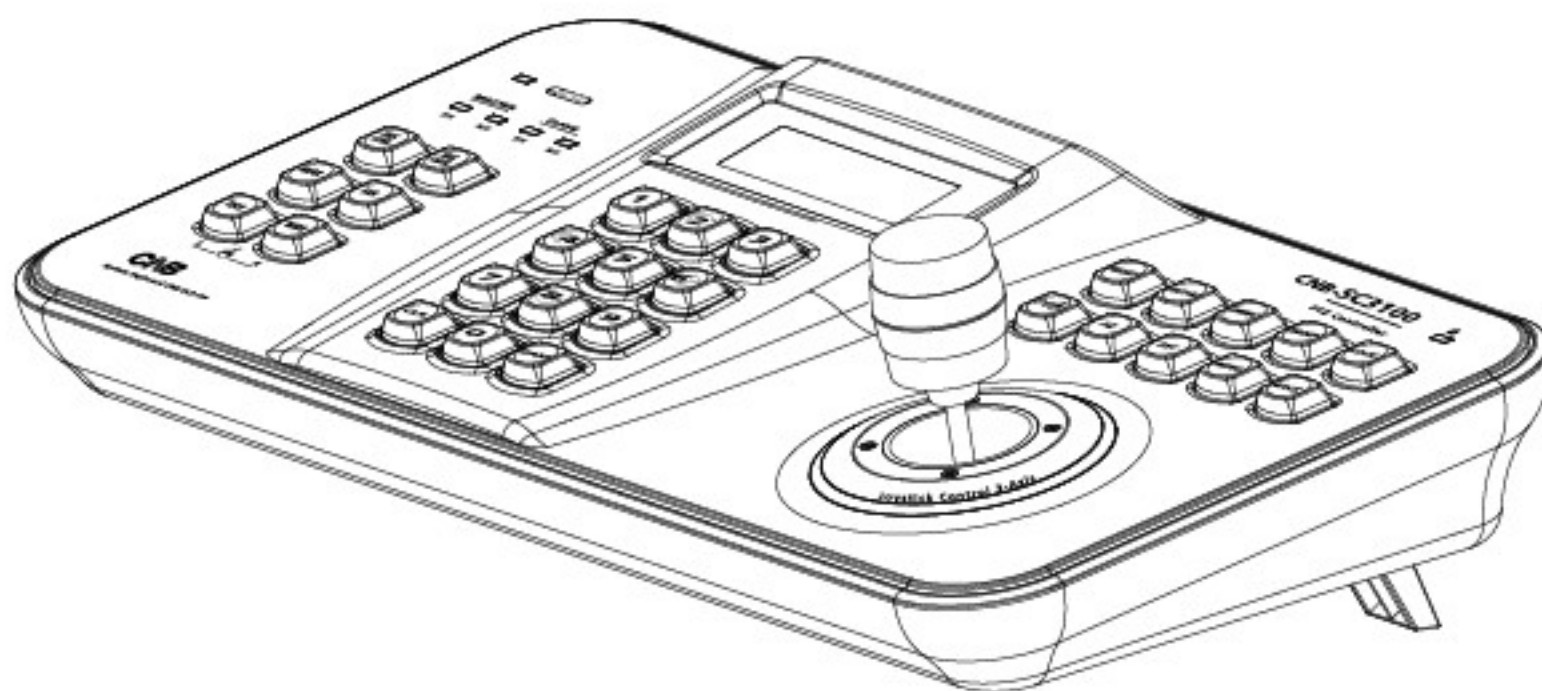

ENG

Installation and User's Manual

This symbol is to alert the user of important operating and maintenance (servicing)





CAUTION

Do not open to prevent electric shock



CAUTION : In order to avoid electric shock, do not open cover or disassemble the product. There are no user serviceable parts inside. Contact the qualified service personnel for service.

4



This symbol is to warn the user of danger from non-insulated high voltage that may be generated within the product to cause electric shock to persons.

SC3100 PTZ CONTROLLER

○ PRECAUTIONS

Safety Precautions

1. Careful Reading of User's Manual

Carefully read all the safety precautions and operation methods of the product before operating.

2. Keeping of User's Manual

The safety and operating manual should be retained for future reference.

3. Attachment

Do not use attachments not recommended by the equipment manufacturer as they may cause hazards.

4. Installation Conditions

Do not use this product under wet or humid conditions.

5. Installation

Do not install the product in unstable position or put on unstable location. The product may cause severe injury to person or serious damage on the product if improperly mounted. Use fixture sold with the product or recommended by the manufacturer. Attach the product according to installation method of the manufacture and be sure to use the parts recommended by the manufacturer.

6. Power Supply

This product is able to operate under rated power supply.

Precautions for Use

● Use of Product

- Check if wiring and power connection are correct before using.
- If any abnormal state or malfunction is observed during operation, stop using and immediately contact the supplier.

● Handling

- Do not disassemble the product and be careful not touch the parts within it.
- In order to avoid any damage on the product, do not drop or apply vibration and impact on it.

● Installation and Storage

- Do not install the product in the place with temperature exceeding operating range.
- Avoid installing the product in moist or dusty place.
- Avoid installing the product on radioactive place. It may cause failure on the parts.
- Avoid installing the product in the place having strong magnetic field or electric signal.
- Avoid installing the product in the place with strong vibration.
- Never expose the product to rain or water.

Contents

1. Introduction and Features	
1) Introduction	7
2) Features	7
2. Product Configuration and System Diagram	
1) Product Configuration	8
2) System Diagram	8
1. System Connection	8
2. RS-232 Pin Layout (D_SUB_MALE)	9
3. Termination DIP Switch	9
4. General Connection	9
3. Name and Function of each Part	
1) Camera Setup Part	10
2) Numeric Pad	11
3) General Control Part	11
4) Camera Control Part	11
5) System LOCK	11
6) Menu Control Part	12
7) Battery Part	12
4. PTZ Control	
1) Power On	12
2) Initial Screen Display	12
3) Camera ID Setup	12
4) Joystick/Camera Operation Method	13
5. Controller Setup	
1) Menu Structure for Setting Controller Interface Device	13
2) Controller Interface Device Setting Mode	14
3) Main Menu for Setting Controller Interface Device	14
4) Joystick Setting Menu	14
5) User Mode Setup Menu	15
6) DVR Device Setup Menu	15
7) Menu Structure for Controlling Controller System	15
8) Controller System Setting Mode	16
9) Main Menu of Controller System Setting	16
10) User Logo Setup Menu	16
11) FACTORY SET Setup Menu	17
6. Controller Firmware upgrade	
1) Controller Firmware upgrade	17
7. Operation List	
1) Operation List	18
8. Product Appearance and Specifications	
1) Product Appearance	19
2) Product Specifications	19

1. Introduction and Features

1) Introduction



SC3100 is a dedicated CCTV controller consisting of 28 function keys, 3 axis joystick and LCD display in order to directly control devices such as Speed Dome Camera, DVR, etc.

2) Features

- One controller is capable of commanding up to 255 devices including Pan/Tilt/Zoom camera.
- With RS-485 communication, it provides long distance remote control up to 1.2km.
- It supports different protocols for each channel. (Pelco D, Pelco P, Samsung Elec, Panasonic)
- It is able to control various kinds of functions of the devices such as Preset, Pattern, Swing, Group, etc.
- Using joystick, it can control Pan/Tilt speed of the camera.
- Adopting 4 Line Text LCD, it provides functions including menu control, company logo input, etc.
- Using function keys for convenience, it is possible to easily operate functions such as Preset, Pattern, Swing, and Group.
- It provides password setup of the administrator.
- It is possible to use up to 4 slave controllers.
- It provides Firmware Upgrade using RS-232.
- It provides USB Mouse function.

2. Product Configuration and System Diagram

1) Product Configuration

		
<p>Main Body</p>	<p>User's Manual</p>	<p>USB CABLE, RJ-45 CABLE(Option), Battery(Option), Adaptor(Option)</p>

● Upon purchasing the product, be sure to check if it contains all of the items listed below.

- KEYBOARD CONTROLLER ▶ 1EA
- USB CABLE ▶ 1EA
- USER'S MANUAL ▶ 1EA

2) System Diagram

1. System connection

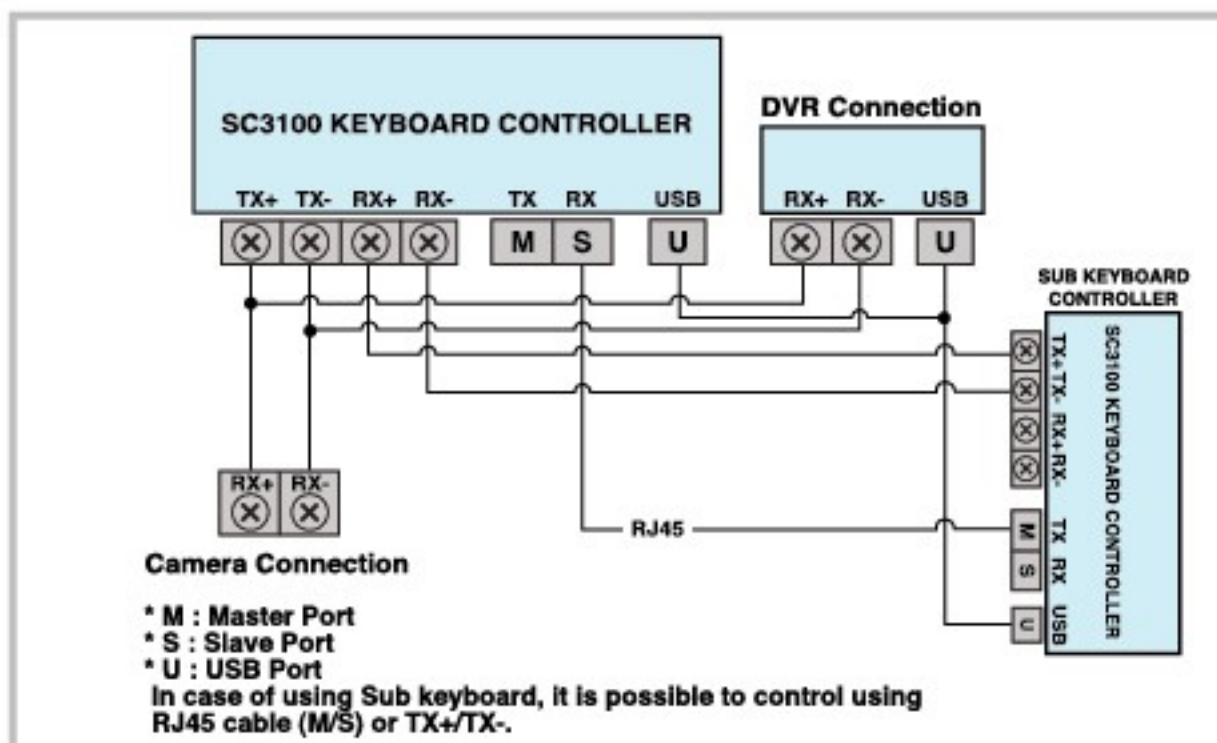

2. RS-232 Pin Layout (D_SUB_MALE)

Terminal	Name
1	—
2	TXD(TRANSMITTED DATA)
3	RXD(RECEIVED DATA)
4	—
5	GND
6	—
7	—
8	—
9	—

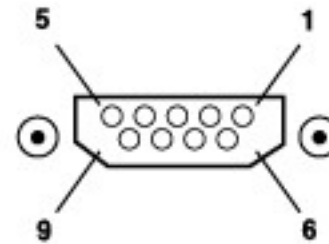

- Supported Firmware Upgrade function(using direct cable).

3. Termination DIP Switch

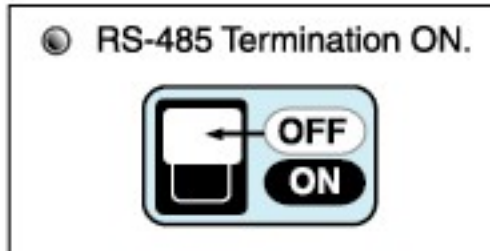

4. General Connection

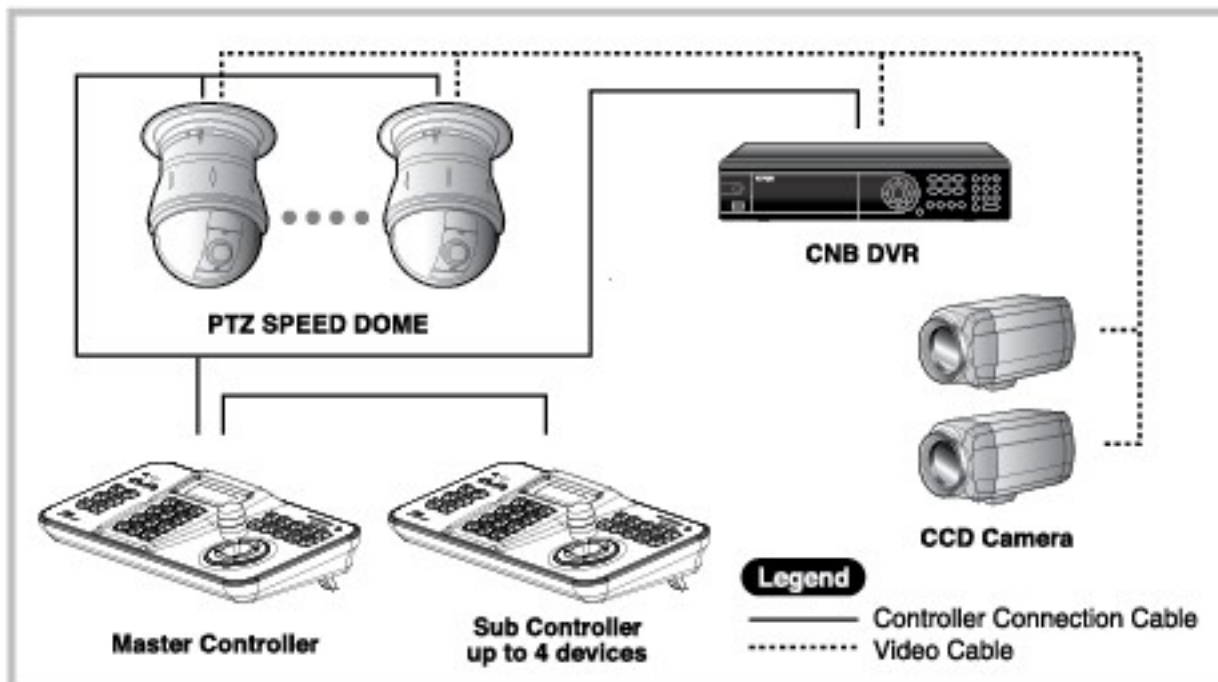

3. Name and Function of each part

1) Camera Setup part

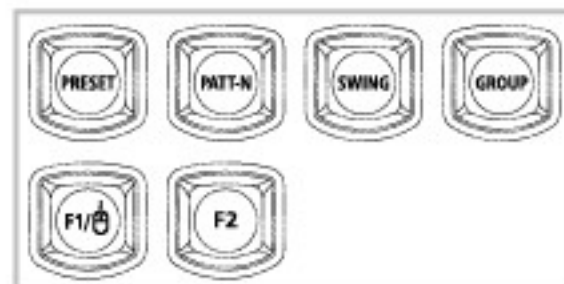

1. PRESET : Used when moving to Preset Point.

● PRESET Setting

- Move the camera to the desired position using joystick or camera control button.
- Enter PRESET No.
- Press PRESET button for 2 seconds, then the current position is set to PRESET No.

● PRESET Execution

- Enter PRESET No.
- Press PRESET button shortly, then the camera moves to the specified PRESET position.

2. PATT-N : It stores jog operation and PRESET operation patterns executed for a specified period, and allows executing them again.

● PATTERN Setup

- Enter desired PATTERN No.
- Press PATT-N button for 2 seconds long.
- Move the camera to the desired position using joystick or camera control button.
- Store/cancel the pattern using NEAR/FAR key button. (applicable to the supported camera only)

● PATTERN Execution

- Enter desired PATTERN No.
- Press PATT-N button shortly, then the desired PATTERN is executed.

3. SWING : This function can select 2 Preset positions remembered on Preset Setup and automatically Monitor repeatedly.

● SWING Setup

- It is possible to directly set up it within camera OSD menu. (applicable to the supported camera only)

● SWING Execution

- Enter desired SWING No.
- Press SWING button shortly, then desired SWING is executed.

4. GROUP : It provides repeated sequential monitoring with specified speed and waiting time by combining PRESET, PATTERN and SWING functions.

● GROUP Setup

- It is possible to directly set it up within camera OSD menu. (applicable on the supported camera only)

● GROUP Execution

- Enter desired GROUP No.
- Press GROUP button shortly, then desired GROUP is executed.

5. F1

- USB Mouse function On/Off(Press it button longly)
- Refer to the section titled "Operation List".

6. F2

- Refer to the section titled "Operation List".

2) Numeric Pad

- ① Numbers (0~9) : Used for entering camera ID, or other functions.
- ② CAM : Used for storing data specified when entering ID.
- ③ CLR : Used for deleting camera ID and other entered function.

**3) General Control part**

- ① IRIS Open / Close : Used to adjust iris of zoom camera.
(applicable on the supported camera only)
- ② TELE/WIDE : Used for executing zoom operation of camera.
TELE : Mouse left button function, WIDE : Mouse right button function
- ③ NEAR/FAR : Used for controlling focus when using zoom lens.
(applicable in the supported camera only)

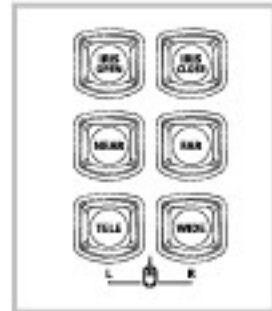
**4) Camera Control part**

- ① Joystick : Used for controlling Pan/Tilt/Zoom operations of camera.
 - Tilt UP : Moves camera upward.
 - Tilt Down : Moves camera downward.
 - Pan Left : Moves camera left.
 - Pan Right : Moves camera right.
 - Zoom Tele : Executes TELE zoom.
 - Zoom Wide : Execute WIDE zoom.

**5) System LOCK**

- ① It is located at the upper right side of keyboard controller and used to protect the controller being operated by other user.
- ② Press it for 2 seconds, then it enters into LOCK status, and released when entering password.



6) Menu Control Part

- ① **MENU** : Press it shortly, then it enters into camera OSD menu. And "MENU" , message is displayed on LCD monitor. Press it shortly again, then it exits out of camera OSD menu. (applicable on the supported protocol only)
- ② **BACK** : Move to the upper-menu (In OSD MENU).
- ③ **SET** : Move to the sub-menu (In OSD MENU). Press it for a specified period with numeric keys, then it enters into function setup mode.



7) Battery Part

- ① As shown on right figure, push the battery cover down to the inside direction and pull, then battery cover is opened.

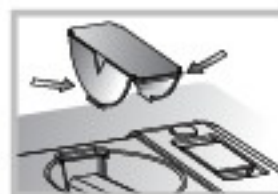

4. PTZ Control

1) Power on

- ① Before turning on the controller power, turn on power for external devices connected to the controller first.
- ② Press a power button on the rear left side of controller.
- ③ As the version, logo and main screen message are displayed on LCD monitor the controller is on enabled status.

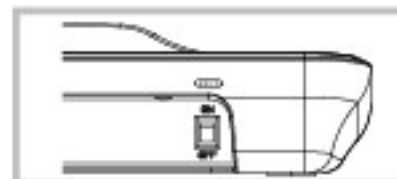

2) Initial Screen Display

- ① **PROTOCOL** : Indicates PROTOCOL of camera selected currently.
- ② **PTZ ADDR** : Indicates ID of camera selected currently.
- ③ **SPEED** : Indicates data rate of camera selected currently.
- ④ **NUM INPUT** : It is displayed only when entering number with numeric pad and indicates the entered number(ID).

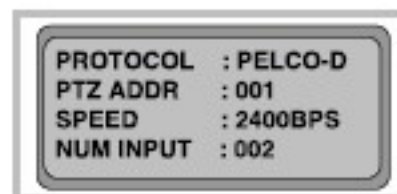

3) Camera ID Setup

- ① Enter desired number form numeric pad.
- ② Selected number is displayed. ex)NUM INPUT : 001
- ③ Press CAM button, then camera ID is set to the selected number.
- ④ It is possible to select number within 1~255. If the number is out of selectable range, camera ID will not be set.

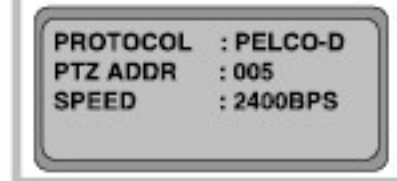
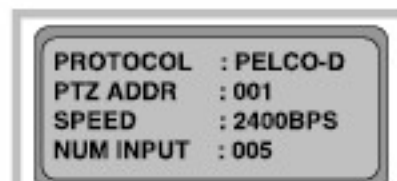

4) Joystick / Camera Operation Method

Using joystick, it is possible to operate pan/Tilt movement of camera.

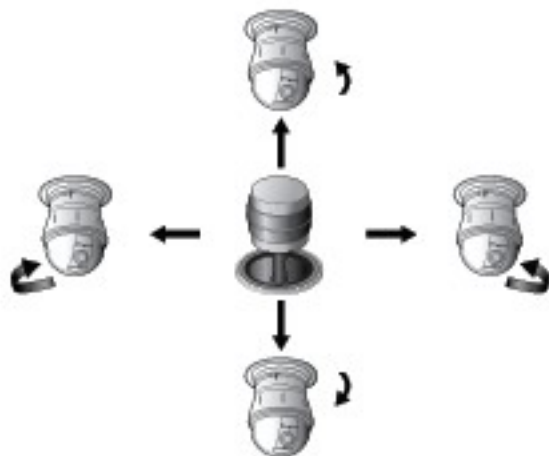

Using joystick, it is possible to operate zoom movement of camera.



5. Controller Setup

1) Menu Structure for Setting Controller Interface Device

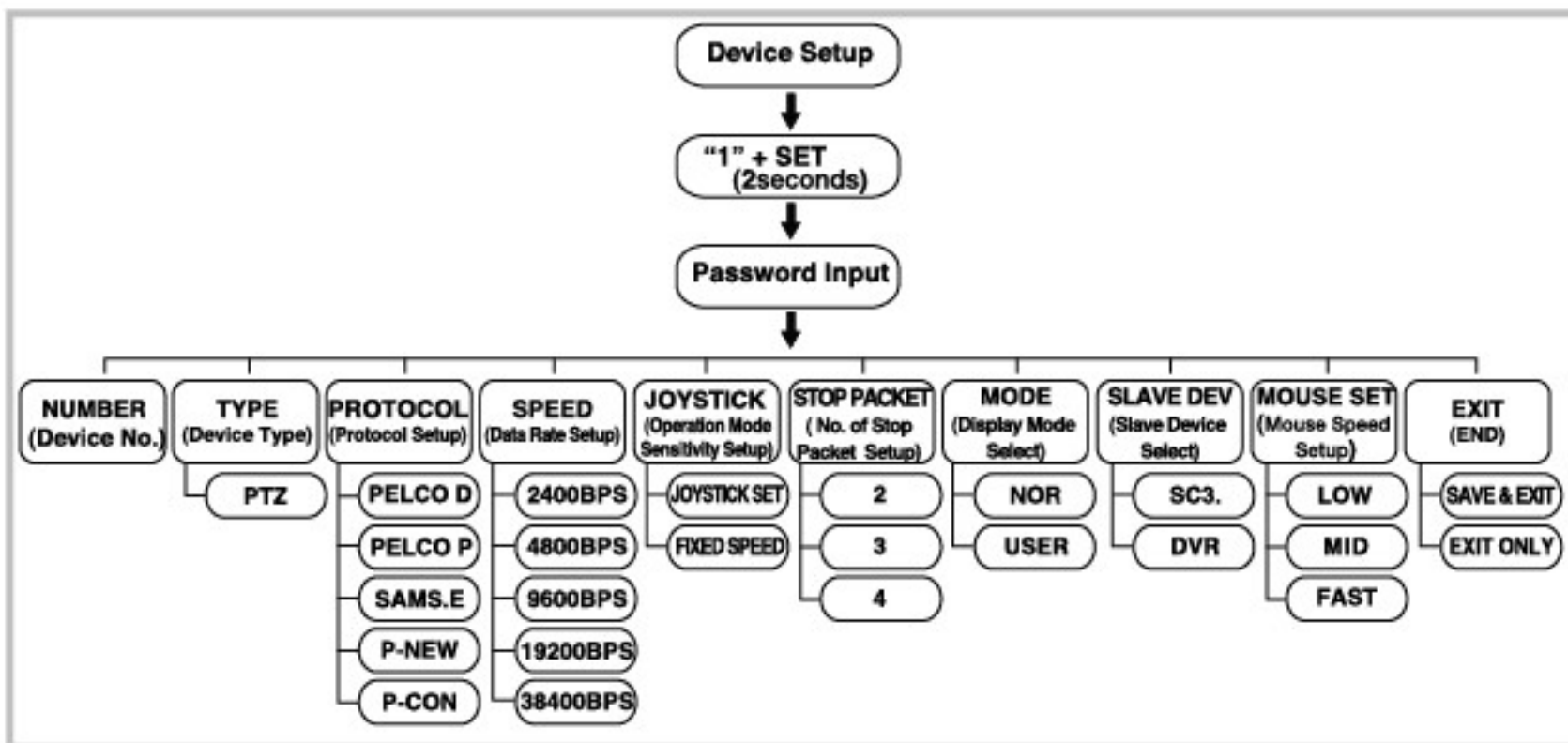

2) Controller Interface Device Setting Mode

- It is a menu to set up controller interface devices.
 - ① Press number 1 on initial screen and SET button for 2 seconds, then password input message is displayed.
 - ② Enter default "0000" set on factory or other password defied by the user arbitrary.
 - ③ When password matches, interface device setup menu is displayed.
 - If password does not match 3 times or it is not entered for 10 seconds, it moves to the initial screen.

```

PROTOCOL : PELCO-D
PTZ ADDR : 001
SPEED    : 2400BPS
    
```

PASSWORD

```

1. NUMBER : 001 ◆
2. TYPE   : PTZ
3. PROTOCOL : PEL-D
4. SPEED  : 2400BPS
    
```

```

1. NUMBER : 001 ◆
2. TYPE   : PTZ
3. PROTOCOL : PEL-D
4. SPEED  : 2400BPS
5. JOYSTICK : SET
    
```

```

6. STOP PACKET : 02
7. MODE        : NOR
8. SLAVE DEV   : SC3.
9. MOUSE SET   : FAST
10. EXIT       :
    
```

3) Main Menu for Setting Controller Interface Device

- ① NUMBER : It indicates camera ID selected currently. It may be a number within 1~255 and set up using joystick and numeric pad. (However, in case of using numeric pad, it is required to enter 3 digits.)
- ② TYPE : It indicates the currently selected device.(SC3100 supports PTZ only.)
- ③ PROTOCOL : It indicates protocol of the currently selected ID. (PELCO D, PELCO P, SAMSUNG ELEC, PANASONIC)
- ④ SPEED : It indicates data rate of the currently selected ID. (2400, 4800, 9600, 19200, 38400).
 - DATA, PARITY and STOP BIT are fixed to 8BIT, NONE and 1BIT respectively.
- ⑤ JOY STICK : It sets up sensitivity, center position and fixed speed of joystick. (See joystick setup menu.)
- ⑥ STOP PACKET : It indicates number of stop packets to be sent when transmitting joystick and function commands.
- ⑦ MODE : It sets up user mode. (See User mode Setup menu)
- ⑧ SLAVE DEV : It sets up slave device. (See DVR Device Setup menu)
- ⑨ MOUSE SET : It sets up mouse speed. When mouse function is used, SC3100 can't control the speed dome.
- ⑩ EXIT : It stores interface device setup menu and moves to initial screen.

4) Joystick Setup Menu

- ① When selecting main menu ⑤ for setting controller interface device and tilting joystick right, a menu as shown on upper right figure is displayed.
 - CENTER : It sets up sensitivity of joystick. (10, 15, 20, 25, 30)
 - ORIGIN SET : When selecting this menu and tilting joystick right, a menu as shown on middle right figure is displayed.
 - It sets up CENTER POSITION of joystick.
 - Position the joystick at the center, and store the position.
- ② When selecting main menu ⑤ for setting controller interface device and tilting joystick left, a menu as shown on lower right figure is displayed.
 - It operates in L (low speed), M (medium speed), F (fast speed) regardless to tilting of the joystick.

```

<JOYSTICK SETTING>
1 CENTER    : 10 RNG->
2 ORIGIN SET : SET
[1] SAVE [0] EXIT
    
```

```

<JOG ORIGIN SETTING>
X : 505 Y : 512
Z : 514
[1] SAVE [0] EXIT
    
```

```

<FIXED JOG SPEED>
[1] 'L' [2] 'M' [3] 'F'
[4] NOT FIXED
[5] SAVE [6] EXIT
    
```

5) User Mode Setup Menu

- ① When selecting main menu ⑦ for setting controller interface device and tilting joystick right, a menu as shown on upper right figure is displayed.
 - MONITOR : It sets up user monitor number and DVR channel number.
 - CAM ID : It sets up the camera ID to be connected to the monitor.
- ② It may be a number within 1~255 and set up using joystick and numeric pad. (However, in case of using numeric pad, it is required to enter 3 digits.)
- ③ SAVE : Tilting joystick left.
EXIT : Tilting joystick right.

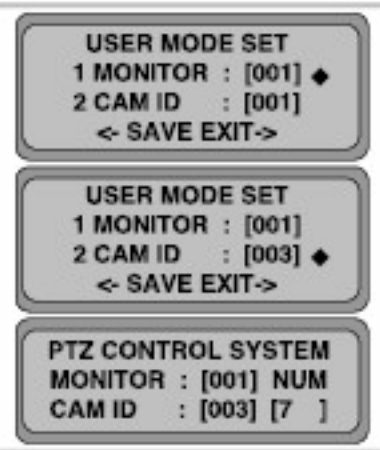

6) DVR Device Setup Menu

- ① When selecting main menu ⑧ for setting controller interface device and tilting joystick right, a menu as shown on upper right figure is displayed.
 - PROT : It sets up the protocol of the DVR. (PELCO D, PELCO P, SAMSUNG ELEC, PANASONIC)
 - SPEED : It sets up the data rate of the DVR. (2400, 4800, 9600, 19200, 38400)



7) Menu Structure for Controlling controller System

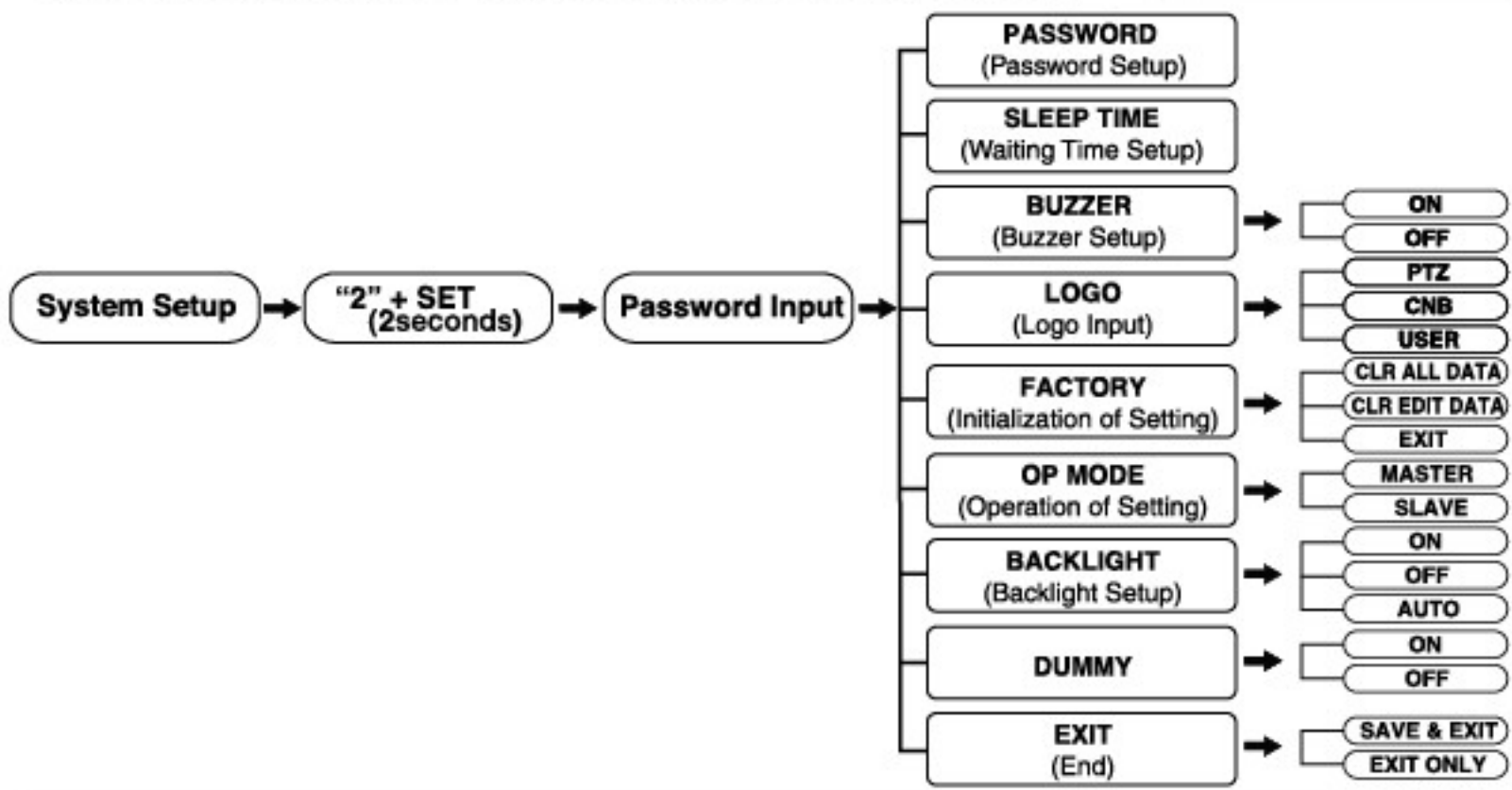

8) Controller System Setting Mode

- ④ This menu sets up controller system.
 - ① Press number 2 on initial screen and SET button for 2 seconds, then password input message is displayed.
 - ② Password input : Refer to the section titled "Controller interface Device Setup Mode."

9) Main Menu of Controller System Setting

- ① PASSWORD : It sets up password to be used to enter into controller interface device and system setup menu. Default is "0000."
 - It is set when all of 4 digits are entered.
- ② SLEEP TIME : It indicates when LCD Backlight turns on. It requires keypad input with larger than 10s and applies only when ⑦ BACKLIGHT is ON.
- ③ BUZZER : It indicates BUZZER ON/OFF of the system.
- ④ LOGO : It allows the user to input logo directly.
 - Refer to user logo setup menu.
- ⑤ FACTORY : It sets the controller to default factory condition.
- ⑥ OP MODE : It indicates Master/ Slave mode. In case of using one master and several slaves connected, slaves shall be set to Slave Mode.
 - SC3100 allows maximum 4 slaves to be connected.
- ⑦ BACKLIGHT : It indicates whether using Backlight of LCD monitor.
 - ON : Backlight turns off when specified time on ② SLEEP TIME has passed.
 - OFF : Backlight turns off.
 - AUTO : When pressing key button, Backlight turns on for 5 seconds.
- ⑧ DUMMY : When using Master/Slave, be sure to set only master controller ON.
- ⑨ EXIT : It stores system setup menu and reboots the system.



10) User Logo Setup Menu

- ① After selecting main menu for setting controller system ④ and selecting USER menu using joystick, a menu is displayed as shown on the right.
 - When tilting joystick up/ down, character is displayed on a specified point.
 - It is possible to input 2 lines of user logo. Position the cursor on up /down arrows and move the joystick upward/downward, then the cursor moves to each line.

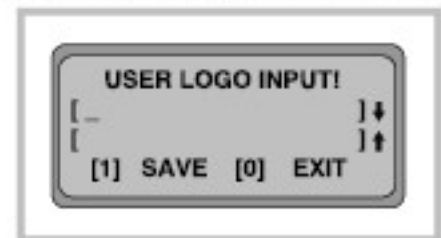

11) FACTORY SET Setup Menu

- ① After selecting main menu for setting controller system ⑤ and tilting joystick right, then a menu is displayed as shown on the right.
- CLR ALL DATA : It initializes controller to the default factory condition.
 - CLR EDIT DATA : It initializes all of data except for Joystick, and PROTOCOL menu.

[1] CLR ALL DATA
[2] CLR EDIT DATA
[0] EXIT
PRESS NUMBER KEY

6. Controller Firmware Upgrade

1) Controller Firmware upgrade



- It is possible to execute firmware upgrade of the controller at PC through RS-232 Port.
- Firmware upgrade application is not provided when purchasing the equipment and only original buyer can obtain the new firmware upgrades.

- ① Check if the controller to be upgraded is connected to PC.
- ② Open : It opens upgrade file (.cnb).
- ③ File Path : When opening upgrade file, it shows the file path.
- ④ Messages : It indicates type of upgrade file.
- ⑤ System Init : When it is selected, the controller is initialized to the default factory condition.
- ⑥ Status : It indicates progress of upgrade.
- ⑦ Progress : It indicates transmission status of upgrade.

7. Operation List

OPERATION	FUNCTION	PEL*	PANAS*		SAMS*
			N*	C*	
[KEYPAD 1-255] + [CAM]	Using for entering camera ID	○	[1~99]	[1~99]	○
[MENU]	Camera OSD MENU ON	○	○	○	○
[MENU]	Camera OSD MENU OFF	X	○	○	○
[SET]	Move to the sub-menu(In OSD MENU)	○	○	○	○
[BACK]	Move to the upper-menu(In OSD MENU)	○	○	○	○
[KEYPAD 1-255] + [PRESET]	PRESET Execution	○	[1~256]	[1~64]	○
[KEYPAD 1-255] + [PRESET] Press it button longly	PRESET Setting	○	[1~256]	[1~64]	○
[KEYPAD 1-255] + [F1] Press it button longly	PRESET Delete	X	X	X	○
[KEYPAD 1-8] + [PATT-N]	PATTERN Execution	○	[1~4]	[1~4]	○
[KEYPAD 1-8] + [PATT-N] Press it button longly	PATTERN Setting	○	[1~4]	[1~4]	X
[KEYPAD 1-8] + [SWING]	SWING Execution	○	SORT 1+SWING	SORT 1+SWING	AUTO PAN
[KEYPAD 1-8] + [GROUP]	GROUP Execution	○	SEQ 1+GROUP	SEQ 1+GROUP	SCAN
[F1]	Save Patterns	X	○	○	X
	Same as F2 function(In OSD MENU)	X	○	○	X
	Change to the Aux Mode	X	X	X	○
	Same as Enter function(In OSD MENU)	X	X	X	○
[F2]	Same as F3 function(In OSD MENU)	X	○	○	X
	Reset function(Press it button shortly)	X	X	X	○
	Reset function(Press it button longly)	X	X	X	Factory
[KEYPAD 0-9]	Select Camera ID	○	○	○	○
	direction key(2,4,6,8, In OSD MENU)	X	○	○	○
	Using for AUX key	X	X	X	○
[CAM]	Move to the sub-menu(In OSD MENU)	X	○	○	X
[CLR]	Move to the upper-menu(In OSD MENU)	X	○	○	X

• PEL* : PELCO PROTOCOL

• PANAS* : PANASONIC (N* : NEW, C* : CONVENTIONAL) PROTOCOL

• SAMS* : SAMSUNG ELEC PROTOCOL

8. Product Appearance and Specifications

1) Product Appearance

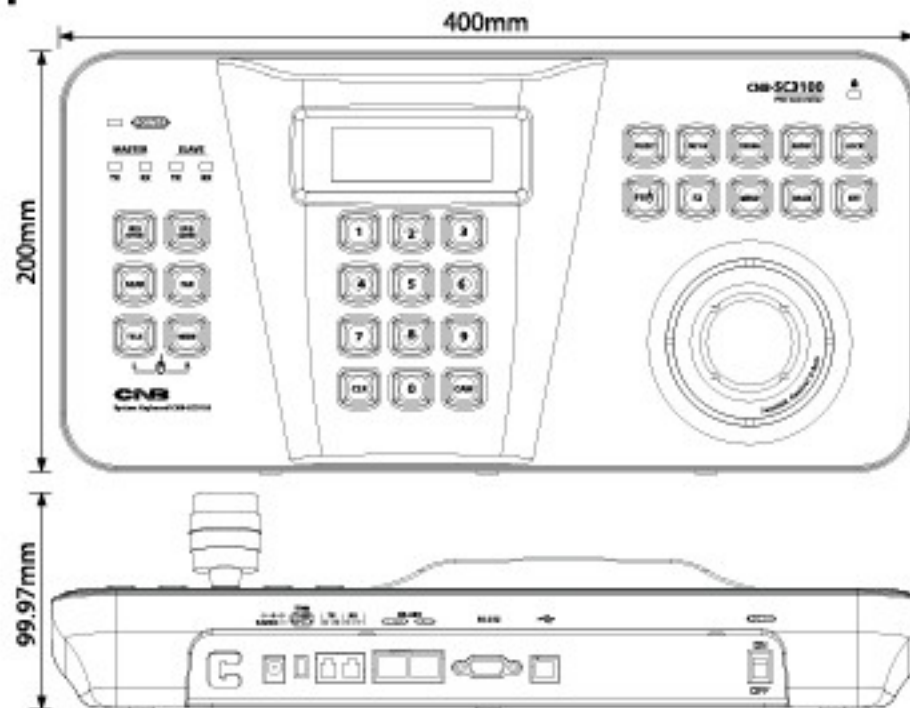

2) Product Specifications

Category	SC3100
Communication Type	Pan/Tilt : RS-485 (Remote control up to 1.2km)
	DVR interface : RS-485, USB
	USB : USB Mouse function support
	Protocol : Pelco D, Pelco P, Samsung Elec, Panasonic
LCD Display	20 x 4 Character LCD
PTZ Control	Joystick (3 Axis Twist Zoom)
Sub keyboard	Max 4 Devices
RS-485 Specification	Type : Asynchronous Serial, 1 Start Bit, No Parity, 1 Stop Bit
	Transmission Type : Half Duplex
	Date Rate : 2400 ~38400 bps
RS-232 Specification	D-SUB 9P, Firmware Upgrade
Operation Power	12V DC / 9V Battery/ USB(PC), Max150mA
Operation Temperature	-10 ~ +50°C / 60%
Dimensions	400(W) x 200(H) x 99.97(D)mm
Weight	About 1.24kg (Excluding Adaptor)

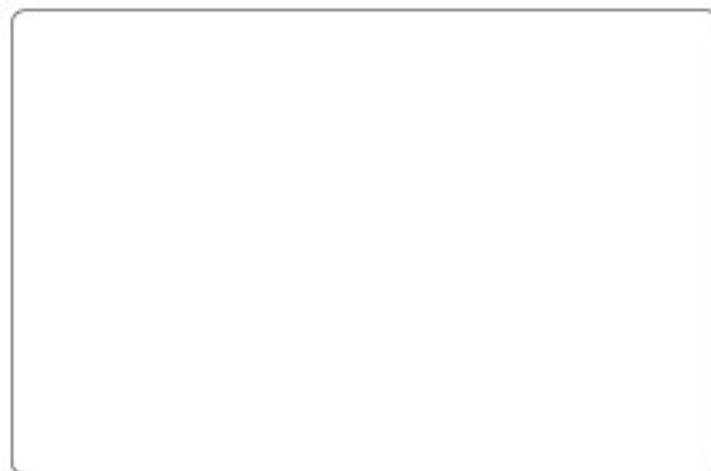

Design and specifications are
subject to change without notice.

(Ver.0906) 3810-0189A
